

COMMON

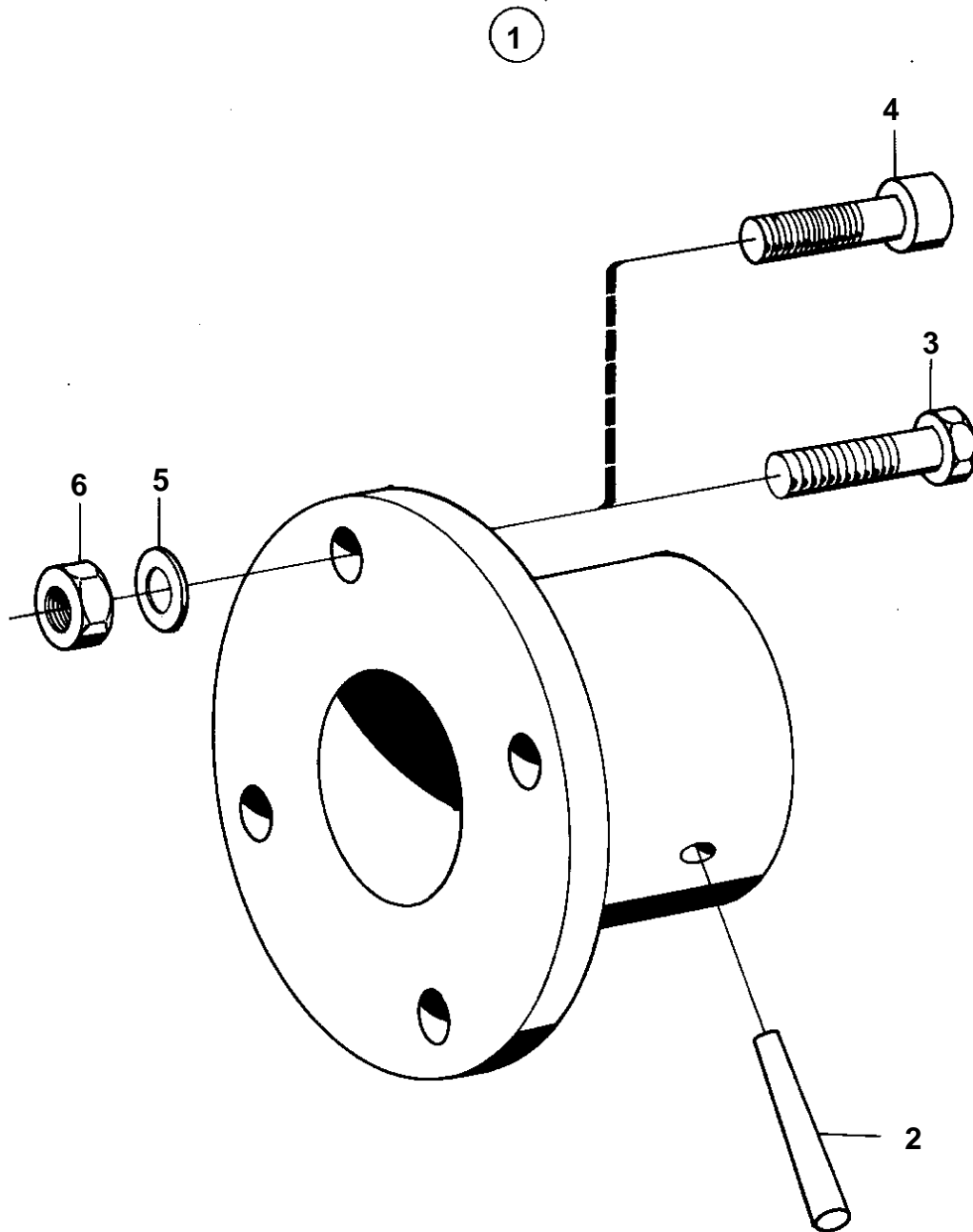

3232

**COMMON**

REF	PART NO.	QTY	DESCRIPTION	NOTES
1	806385	1	Companion flange	30MM HOLE FOR PROPELLER SHAFT.
2	907599	1	· Pin	
3	955319	4	· Screw	L = 35 MM
4	959239	4	· Screw	L = 30 MM
5	941908	4	· Spring washer	
6	955783	4	· Nut	