

**2.60 IN./102MM
 TORPEDO DIA.**

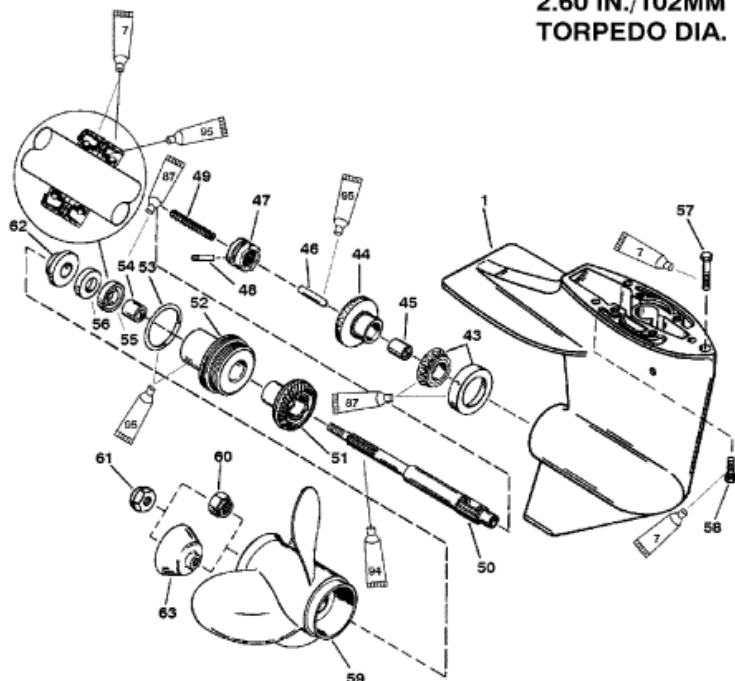

-  Loctite 271 (92-809820)
-  Super Duty Gear Lubricant (92-13783A24)
-  Anti-Corrosion Grease (92-76376A8)
-  2-4-C With Teflon (92-825407A12)

19709

Parts List

Ref	Class	Part	Description	Qty	Comment	Footnote
-	1666	8833A13	GEAR HOUSING	1	(SHORT) BLACK	
-	1666	8833A15	GEAR HOUSING	1	(LONG) BLACK	
-	1666	8833A14	GEAR HOUSING	1	(SHORT) GRAY	
-	1666	8833A16	GEAR HOUSING	1	(LONG) GRAY	
-	1666	8833A19	GEAR HOUSING-COMPLETE	1	(TRACKER GRAPHITE GRAY)	
1	1666	8833A17	GEAR HOUSING, Basic	1	(BLACK)	
1	1666	8833A18	GEAR HOUSING	1	(GRAY)	
1	1666	8833A20	GEAR HOUSING	1	(TRACKER GRAPHITE GRAY)	
43	31	821321A 1	ROLLER BEARING	1		
44	43	821924A 1	FORWARD GEAR (26 TEETH)	1		
45	23	41367	BUSHING	1		
46		813139	CAM FOLLOWER	1		
47	52	821930A 1	CLUTCH ASSEMBLY	1		
48	17	823951	CROSS PIN	1		
49	24	42204	SPRING	1		
50	44	821929	PROPELLER SHAFT	1		
51	43	821926 1	REVERSE GEAR, 13-26 (26 TEE	1		
52		42144A 3	BEARING CARRIER	1		
53	25	33145	O-RING, (1.984 x .139)	1		3,4
54	23	821927	BUSHING	1		
55	26	99325	SEAL	1		4
56	26	821928	OIL SEAL	1		4
57	10	824071 10	SCREW, (M8 x 50)	1		
58	10	824071 7	SCREW, (M8 x 30)	2		
59	48	828156A12	PROPELLER, (9.00 x 9.00)	1		
59	48	828152A12	PROPELLER, 3-Blade (9.25 x 7.00)	1		
59	48	828150A12	PROPELLER, (9.25 x 6.50)	1		
60	23	42091 1	SPACER	1		
61	11	13914	NUT, (M10)	1		
62		821932	THRUST HUB (1.390 DIA.)	1		
62		821932 1	THRUST HUB (1.510 DIA.)	1		
63		822559A 1	HI-REVERSE THRUST CUP	1		
-	26	41365A 3	SEAL KIT	1		
-	27	42364A92	ENGINE GASKET SET	1		