

# Velvet Drive Marine Transmission Service Manual Model CR2

---

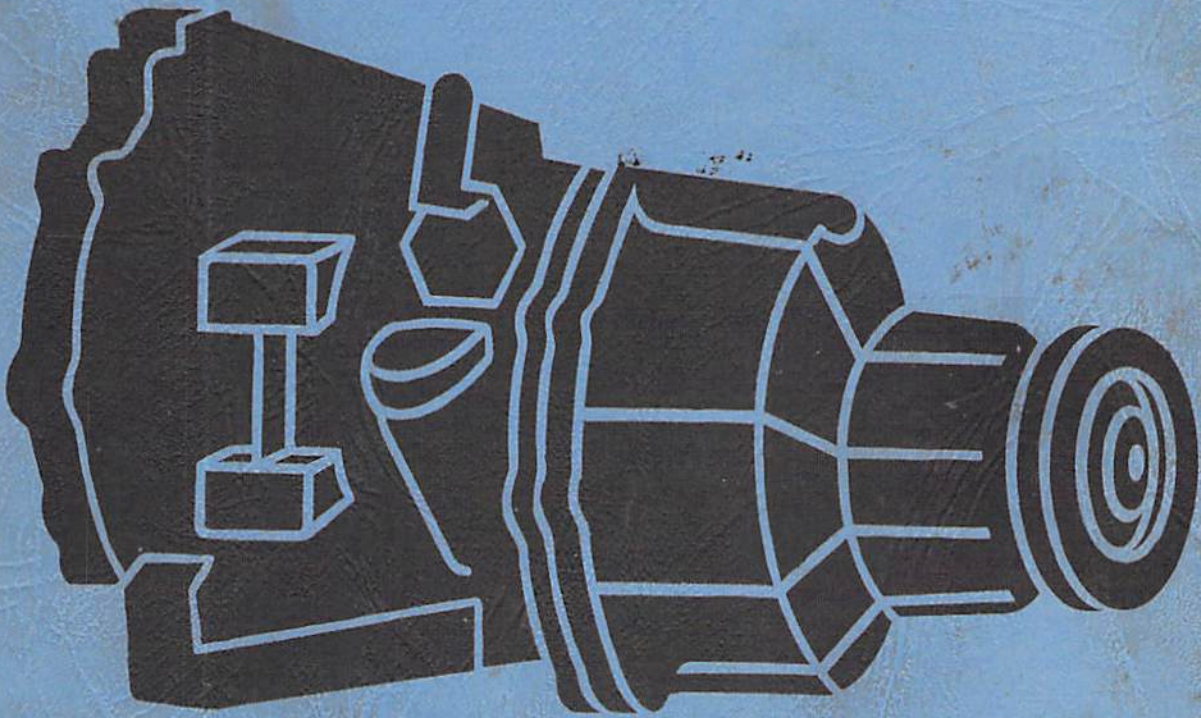

---

**Warner Gear**

Division of Borg-Warner Corporation

#1151

SERVICE MANUAL  
PRICE \$2.50

---

# Velvet Drive Marine Transmission Service Manual Model CR2

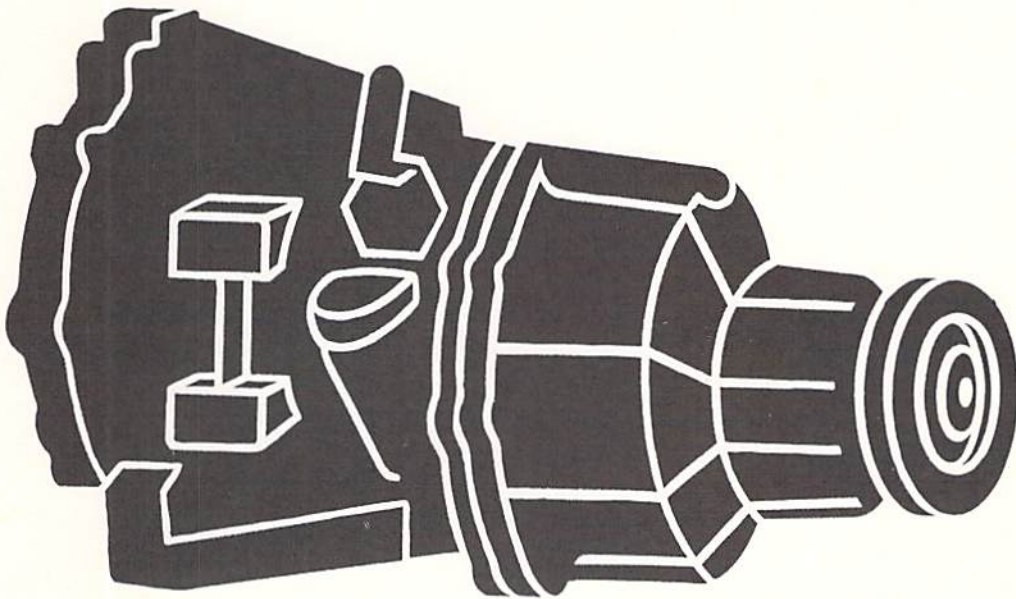

---

**Warner Gear**

---

**BORG WARNER**® Transportation  
Equipment

Division of Borg-Warner Corporation  
P.O. Box 2688, Muncie, Indiana 47302  
Telephone 317/284-8411 Telex: 027-491

FORM 1151 / 7-75  
PRINTED IN U.S.A.

## INDEX

TRANSMISSION DESCRIPTION .....	4
INSTALLATION DRAWING .....	6
INSTALLATION INSTRUCTIONS .....	7
PROPELLER SHAFT COUPLINGS .....	7
TRANSMISSION OPERATION .....	8
HYDRAULIC FLUID RECOMMENDATIONS .....	9
PARTS LIST FOR FORWARD & REVERSE PORTION .....	10
PARTS LIST FOR REDUCTION PORTION .....	12
SERVICE KITS .....	14
TRANSMISSION DISASSEMBLY .....	15
TRANSMISSION ASSEMBLY .....	15
TROUBLE SHOOTING CHART .....	19
BOLT TORQUE CHART .....	19

## TRANSMISSION DESCRIPTION

CR2 units are available in twenty-four different assemblies. Twelve assemblies are available in each of two sizes. The smaller Model 10-13 units are similar in size to the 71C transmission. The larger Model 10-14 units are similar in size to the 72C transmissions. Four different ratios are available in each of three types in both sizes. One type has output shaft rotation the same as engine when forward is selected. One type has output shaft rotation opposite to engine when forward is selected. A chart shows the various CR2 assemblies currently available.

The Velvet Drive CR2 marine gear was designed especially for twin screw applications. Its counter rotating feature eliminates the need for opposite rotating engines.

CR2 assemblies consist of a forward and reverse portion built into the front case and a reduction portion built into the reduction housing.

### FORWARD AND REVERSE PORTION

The forward and reverse portion consists of a planetary gear set, forward clutch, reverse clutch, oil pump, pressure regulator valve and rotary control valve assembled into a cast iron case. A direct drive ratio is provided for forward operation. All 10-13 models have a 1.00: 1.00 ratio in reverse. All 10-14 models have a 1.10: 1.00 ratio in reverse. Helical gearing is used to provide quieter operation than can be obtained with spur gearing.

The transmission is fast shifting to give the boat operator complete control of the vessel. Shifting is accomplished by fore and aft movement of the shift lever. This movement rotates the control valve to direct oil under pressure to the required channels.

Oil pressure is provided by a crescent type pump. The pump drive gear is keyed to the input shaft and operates at transmission input shaft speed. Pressure lubrication is provided at all times in forward, neutral and reverse.

### REDUCTION PORTION

The reduction portion is housed in the rear or reduction housing. The reduction drive gear is splined to the output shaft of the forward and reverse transmission and it is meshed with the ring gear on units having the same input and output shaft rotation when operated in forward. The reduction drive gear drives an idler gear which drives the ring gear on units having the output shaft turning opposite to input shaft when operated in forward. The ring gear and output shaft are one piece construction and are held firmly in position by tapered bearings.

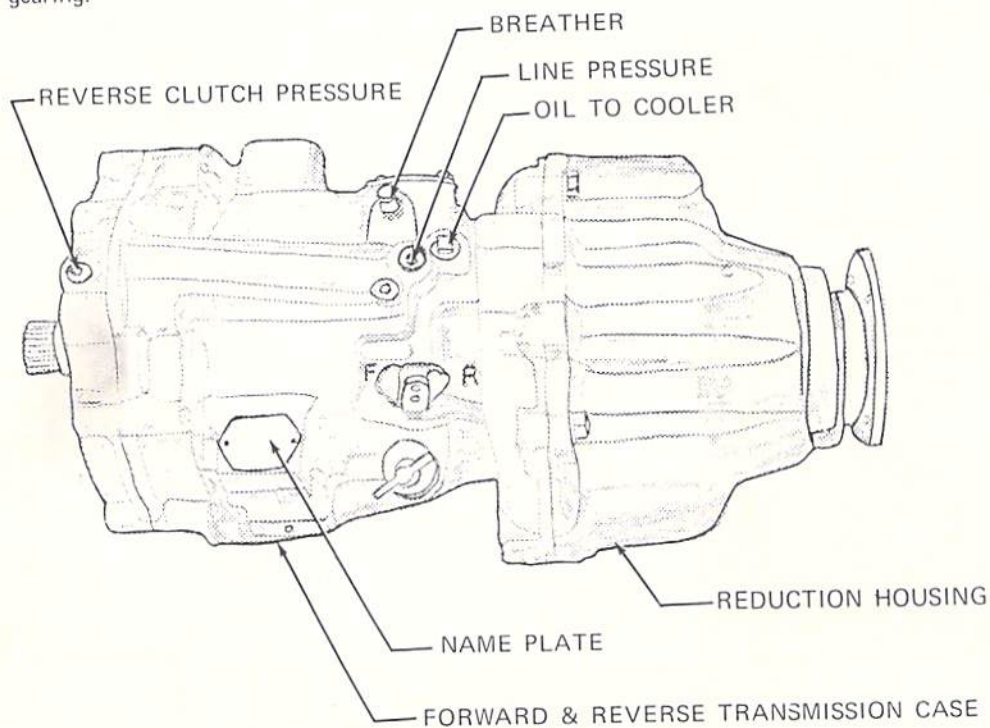

**CR2  
(DROP CENTER ASSEMBLIES)**

NE=NON-AUTOMOTIVE ENGINE  
E=AUTOMOTIVE ENGINE  
O=AUTOMOTIVE OPPOSITE



ASSEMBLY NUMBER	REDUCTION RATIO		SHAFT ROTATION (1)			PUMP SETTING (2)	PROPELLER REQUIRED (3)	NAME PLATE STAMPED
	FORWARD	REVERSE	INPUT	OUTPUT				
				FORWARD	REVERSE			
10-13-000-001	1.58:1	1.58:1	(4) L.H.	ENGINE	OPPOSITE ENGINE	→	L.H.	E-1.6
10-13-000-002	1.58:1	1.58:1	L.H.	OPPOSITE ENGINE	ENGINE	→	R.H.	O-1.6
10-13-000-003	2.03:1	2.03:1	L.H.	ENGINE	OPPOSITE ENGINE	→	L.H.	E-2.0
10-13-000-004	2.03:1	2.03:1	L.H.	OPPOSITE ENGINE	ENGINE	→	R.H.	O-2.0
10-13-000-005	2.47:1	2.47:1	L.H.	ENGINE	OPPOSITE ENGINE	→	L.H.	E-2.5
10-13-000-006	2.47:1	2.47:1	L.H.	OPPOSITE ENGINE	ENGINE	→	R.H.	O-2.5
10-13-000-007	2.93:1	2.93:1	L.H.	ENGINE	OPPOSITE ENGINE	→	L.H.	E-3.0
10-13-000-008	2.93:1	2.93:1	L.H.	OPPOSITE ENGINE	ENGINE	→	R.H.	O-3.0
10-13-000-009	1.58:1	1.58:1	R.H.	ENGINE	OPPOSITE ENGINE	←	R.H.	NE-1.6
10-13-000-010	2.03:1	2.03:1	R.H.	ENGINE	OPPOSITE ENGINE	←	R.H.	NE-2.0
10-13-000-011	2.47:1	2.47:1	R.H.	ENGINE	OPPOSITE ENGINE	←	R.H.	NE-2.5
10-13-000-012	2.93:1	2.93:1	R.H.	ENGINE	OPPOSITE ENGINE	←	R.H.	NE-3.0
10-14-000-001	1.58:1	1.74:1	L.H.	ENGINE	OPPOSITE ENGINE	→	L.H.	E-1.6
10-14-000-002	1.58:1	1.74:1	L.H.	OPPOSITE ENGINE	ENGINE	→	R.H.	O-1.6
10-14-000-003	2.03:1	2.23:1	L.H.	ENGINE	OPPOSITE ENGINE	→	L.H.	E-2.0
10-14-000-004	2.03:1	2.23:1	L.H.	OPPOSITE ENGINE	ENGINE	→	R.H.	E-2.0
10-14-000-005	2.47:1	2.72:1	L.H.	ENGINE	OPPOSITE ENGINE	→	L.H.	E-2.5
10-14-000-006	2.47:1	2.72:1	L.H.	OPPOSITE ENGINE	ENGINE	→	R.H.	O-2.5
10-14-000-007	2.93:1	3.22:1	L.H.	ENGINE	OPPOSITE ENGINE	→	L.H.	E-3.0
10-14-000-008	2.93:1	3.22:1	L.H.	OPPOSITE ENGINE	ENGINE	→	R.H.	O-3.0
10-14-000-009	1.58:1	1.74:1	R.H.	ENGINE	OPPOSITE ENGINE	←	R.H.	NE-1.6
10-14-000-010	2.03:1	2.23:1	R.H.	ENGINE	OPPOSITE ENGINE	←	R.H.	NE-2.0
10-14-000-011	2.47:1	2.72:1	R.H.	ENGINE	OPPOSITE ENGINE	←	R.H.	NE-2.5
10-14-000-012	2.93:1	3.22:1	R.H.	ENGINE	OPPOSITE ENGINE	←	R.H.	NE-3.0

- (1) VIEWED FROM BEHIND COUPLING FACING ENGINE
- (2) VIEWED FROM IN FRONT OF TRANSMISSION INTO PUMP
- (3) VIEWED FROM BEHIND BOAT
- (4) L.H. - LEFT HAND OR COUNTERCLOCKWISE  
R.H. - RIGHT HAND OR CLOCKWISE

**CAUTION:** Engine rotation must be the same as shown on the chart (input shaft rotation). Failure to comply can result in premature gear damage.

FIG. 1 INSTALLATION TEETH DRAWING FOR CR2 TRANSMISSIONS

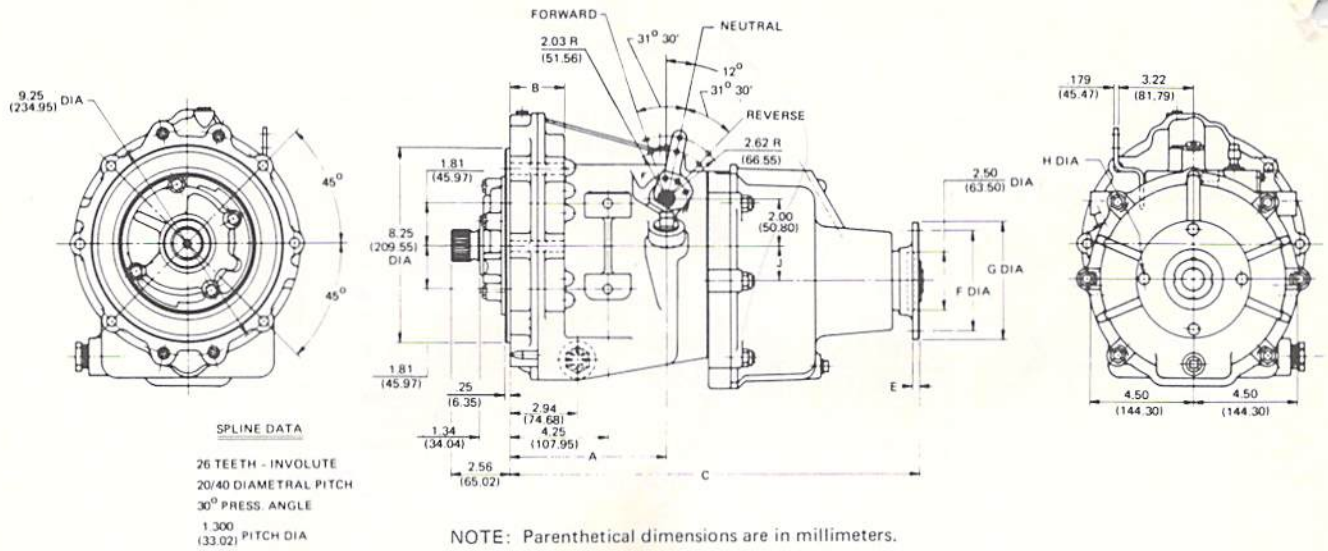

MODEL	A	B	C	E	F DIA	G DIA	H DIA	REDUCTION	J OFFSET DIMS. OUTPUT ROTATION	
									ENGINE	OPPOSITE
<b>71C SERIES</b>										
10-13	6.82 (173.23)	2.39 (60.71)	18.42 (467.87)	.31 (7.87)	4.25 (107.95)	5.00 (127.00)	.45 (11.43)	1.58	1.23 (31.24)	1.06 (26.92)
								2.03	1.66 (42.16)	1.49 (37.85)
								2.47	1.95 (49.53)	1.77 (44.96)
								2.93	2.16 (54.86)	1.99 (50.55)
<b>72C SERIES</b>										
10-14	7.76 (197.10)	2.64 (67.06)	19.36 (491.74)	.31 (7.87)	4.25 (107.95)	5.00 (127.00)	.45 (11.43)	1.58	1.23 (31.24)	1.06 (26.92)
								2.03	1.66 (42.16)	1.49 (37.85)
								2.47	1.95 (49.53)	1.77 (44.96)
								2.93	2.16 (54.86)	1.99 (50.55)

GENERAL SPECIFICATIONS

MODEL	MAXIMUM SAE HP INPUT		AVAILABLE RATIOS	OUTPUT ROTATION	DRY WEIGHT
	GASOLINE	DIESEL			
10-13	255 @ 4200 rpm	145 @ 3200 rpm	1.58, 2.03, 2.47.	OPTIONAL	162 lb. (73.5 kg.)
10-14	380 @ 4200 rpm	185 @ 3200 rpm	2.93 to 1.00		175 lb. (79.4 kg.)

NOTE: The above transmission ratings are subject to change without notice and are intended only as a general guide. Specific applications should be referred to Warner Gear for engineering assistance.

## INSTALLATION INSTRUCTIONS

An Installation Manual may be acquired from Warner Gear if you have a need for more complete instructions than those given in the following paragraphs.

Before mounting the transmission on the engine, be sure that the arrow located at the top front of the pump points in the direction the unit will be driven by the engine. The pump on CR2 units should not be changed from the original factory setting as shown in the chart on page 5.

An oil cooler must be properly connected to the transmission before the engine is cranked or started. Failure to properly connect the oil cooler results in overpressurization and possibly blowing out of the forward clutch piston. Warranty claims due to this type of failure will not be allowed.

An oil cooler of sufficient size should be used to assure that maximum oil temperature of transmission will not exceed 190° F. (88° C). Failure to provide proper cooling may result in damage to the transmission from insufficient oil flow and pressures caused by high temperatures.

The Warner Gear 9 or 12 inch coolers or a cooler of equal capacity will usually give proper cooling. A final test of the completed installation should be made to determine that oil to cooler leaving the transmission does not exceed 190° F.

The cooler outlet on CR2 units is located just behind the selector valve at rear near top of forward and reverse transmission case. Oil from cooler should be returned to the sump fitting at the lower right side of the forward and reverse transmission case. Red plastic plugs are currently installed in the cooler openings to identify their location.

Water should be fed directly to the cooler. Water inlet temperatures above 110° F. are permissible only if larger sized coolers are used to maintain the recommended transmission temperature.

Cooler oil lines should have a .41 inch (1.04 cm.) or larger inside diameter.

Air can be trapped above the oil in a cooler unless the cooler out fitting is located at the highest point on the cooler. Trapped air reduces cooling capacity, causes foaming, pump cavitation, and loss of oil through the breather.

Horizontal mounting is preferred because it prevents oil from draining from the cooler. Drain back from a cooler which is mounted higher than the transmission sump will give a misleadingly high reading of the sump oil level.

The transmission and engine should be installed so that the maximum angle relative to horizontal does not exceed 15° when the boat is at rest, and should not exceed 20° when operating at the worst bow high condition. A higher angle of installation along with low oil level can permit pump cavitation when operating in rough water where pitching and rolling tends to throw the oil away from the pump inlet.

The remote controls should position transmission selector lever exactly in the forward, neutral and reverse poppet positions. The control lever should always be located over the letter "F" on the case casting when the boat moves in a forward direction. Early failure can be expected when the transmission is operated in reverse when boat moves forward.

The Warranty is cancelled if the shift lever poppet spring and/or ball is permanently removed or if the control lever is changed or repositioned in any manner, or if linkage between remote control and transmission shift lever does not have sufficient travel in both directions.

## PROPELLER SHAFT COUPLINGS

### COUPLING TO SHAFT ASSEMBLY

See form 1044 for specifications of couplings available from Warner Gear.

The propeller shaft coupling must be keyed to the propeller shaft. The key should be a close fit with keyway sides, but should not touch the top of the keyway in the coupling hub. The coupling should be a light press fit on the shaft, and may be warmed in hot oil to permit easier assembly.

**NOTE:** *Propeller shaft coupling distortion may occur when the propeller shaft is a few thousandths under the size required for the particular coupling, thus permitting the coupling to cock and distort as the set screws are tightened. A blank coupling should be machined to fit an undersize shaft. Distorted coupling may be refaced in a lathe.*

Two optional methods for fastening the coupling to the propeller shaft are used. Type 1 couplings are pilot drilled through one side only, and the shaft and opposite side of

the coupling must be drilled with the coupling in position on the propeller shaft. A 1/4 inch (6.35 mm) stainless steel spring pin must then be driven into the coupling and shaft to retain these parts. The spring pin should be selected so that it will be the same length as the coupling hub diameter and should be approximately flush with the coupling when assembled.

Type 2 couplings are drilled and tapped for set screws which are used to retain these parts. Some propeller shaft couplings are drilled and tapped for set screws, and are also pilot drilled for spring pin installation.

### TRANSMISSION COUPLING TO PROPELLER SHAFT COUPLING ALIGNMENT

Vibration, gear noise, loss of RPM and premature oil seal and bearing failure can be caused by misalignment of the transmission coupling and propeller shaft coupling. The propeller shaft is usually fixed in the boat structure, and alignment is achieved by adjusting the engine mounts or by changing engine mount shims.

Preliminary alignment of the coupling faces should be carefully made prior to installing the engine and transmission hold-down bolts. A final alignment check should be made after the boat has been placed in the water. The fuel tanks should be filled and a normal load should be in position when making the final shaft alignment check.

It is common for a boat to change with age or various loads. An alignment check should be made at the beginning of each boating season.

Check coupling alignment with all bolts removed from the couplings. Hand hold couplings together with the snap fit engaged and check to determine the maximum clearance between couplings. Rotate the propeller shaft and then rotate the transmission coupling through at least one complete turn, stopping at 90° intervals and using a feeler gage (see figure 2) to check the air gap between the two.

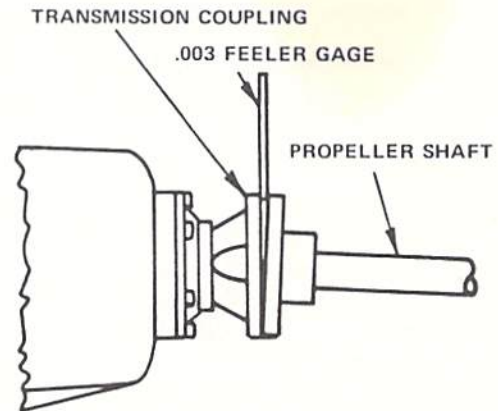

FIG. 2 CHECKING COUPLING ALIGNMENT

## TRANSMISSION OPERATION

### STARTING ENGINE

Place transmission selector in neutral before starting engine. Shifts from any selector position to any other selector position may be made at any time and in any order if the engine speed is below 1000 RPM; however, it is recommended that all shifts be made at the lowest feasible engine speed.

### NEUTRAL

Move the shift lever to the center position where the spring loaded ball enters the chamfered hole in the side of the shift lever and properly locates lever in neutral position. With shift lever so positioned, flow of oil to clutches is blocked at the control valve. The clutches are exhausted by a portion of the valve and complete interruption of power transmission is insured.

### FORWARD

Move the shift lever to the extreme forward position where the spring loaded ball enters the chamfered hole in the side

of the shift lever and properly locates lever in forward position.

### REVERSE

Move transmission shift lever to the extreme rearward position where the spring loaded ball enters the chamfered hole in the side of the shift lever and properly locates it in the reverse position.

### FREE WHEELING

Short periods of free wheeling are permissible. Extended periods of free wheeling at high speeds may cause the transmission to overheat; therefore, it is recommended that transmission sump temperature be monitored and free wheeling discontinued whenever 230°F. or 111°C. is reached. A temperature alarm kit, for installation in transmission sump, is available from your Velvet Drive dealer. The transmission may be cooled by operating the engine to circulate the transmission oil and cooler water. Free wheeling



can be continued after the transmission has been cooled to a safe temperature. The transmission should be in good condition and full of fluid anytime free wheeling is permitted.

A suitable propeller shaft locking device may be found advantageous on installations requiring extended periods of free wheeling at high speeds.

## HYDRAULIC FLUID RECOMMENDATIONS

Use automatic transmission fluid of the type used in passenger cars. SAE No. 30 diesel engine oil may be used if engine speed will not exceed 3000 RPM and oil is cooled with engine jacket water. The use of transmission oil additives is not recommended.

### FILLING TRANSMISSION

**CAUTION:** Be sure the transmission is filled and a cooler is properly installed before cranking or starting engine.

The transmission, cooler, and cooler lines must be filled and the complete hydraulic system must be purged of air prior to making the final oil level check. A properly installed cooler will be self-purging. The oil cooler and cooler lines will be filled from the transmission and after a brief period of operation, it will be necessary to add oil to raise oil level to the full mark.

### OIL CAPACITY

Approximately 2-1/2 quarts (2.36 liters) will fill most CR2 units to the oil level mark on dipstick. Many variables have a direct relationship to oil capacity. Additional oil will be required to fill oil cooler and cooler lines. The angle of installation will make a difference in the quantity of oil required to fill the transmission.

### CHECKING OIL LEVEL

The oil level should be maintained at the full mark on the dipstick. Check oil level prior to starting the engine.

### FILLING AND CHECKING THE HYDRAULIC SYSTEM

The Velvet Drive hydraulic circuit includes the transmission, oil cooler, cooler lines and any gauge lines connected into the circuit. The complete hydraulic circuit must be filled when filling the transmission and this requires purging the system of air before the oil level check can be made. The air will be purged from the system if the oil level is main-

## SHIFTING

Except in an emergency, shift from forward to reverse below high idle engine speeds (approximately 1000 RPM). This will prevent damage or abuse of the marine gear which might necessitate its early repair.

tained above the pump suction opening while the engine is running at approximately 1500 RPM. The presence of air bubbles on the dipstick indicates that the system has not been purged of air.

New applications or a problem installation should be checked to insure that the oil does not drain back into the transmission from the cooler and cooler lines. Check the oil level for this drain back check only, immediately after the engine is shut off and again after the engine has been stopped for more than one hour (overnight is excellent). A noticeable increase in the oil level after this waiting period indicates that the oil is draining from cooler and cooler lines. The external plumbing should be changed to prevent any drain back.

### CHANGING OIL

A seasonal oil change is recommended in pleasure boats. Work boats may require more frequent changes. Change oil anytime the oil becomes contaminated, changes color, or becomes rancid smelling.

### OIL TEMPERATURE

A maximum sump oil temperature of 190° F. (88 c) is recommended. Discontinue operation anytime sump oil temperature exceeds 230° F. (110 c).

### OPERATING PRESSURES

#### At 600 engine RPM

In neutral	117-130 PSI	9.14 kgs./sq. cm.
Forward clutch	85-105 PSI	5.98-7.38 kgs./sq. cm.
Reverse Clutch	88-102 PSI	6.19-7.17 kgs./sq. cm.

#### At 2000 engine RPM

Forward clutch	95-130 PSI	6.68-9.14 kgs./sq. cm.
Reverse Clutch	95-130 PSI	6.68-9.14 kgs./sq. cm.

**PARTS LIST FOR FORWARD & REVERSE  
PORTION OF CR2 UNITS**

INDEX NO.	PART NUMBER	PART DESCRIPTION	NO. REQ.		INDEX NO.	PART NUMBER	PART DESCRIPTION	NO. REQ.	
			10-13 UNITS	10-14 UNITS				10-13 UNITS	10-14 UNITS
32	0000179791	1/4-20 x 5/8 Hex Head Bolt	3	3	78	4755	Clutch Spring Snap Ring (2)	1	1
33	71-4	Valve Cover	1	1	79	3-37	Clutch Spring	1	1
34	71-14	Valve Cover Gasket (1)	1	1	80	5C-33	Clutch Spring Bearing Ring	1	1
N1	10-05-739-001	Valve & Spring Assembly	1	1	81	5L-36	Sealing Ring (1) <i>123C2</i>	1	1
35	4821	Snap Ring (2)	1	1	82	71-45	Forward Clutch Piston	1	1
36	71-246	Valve Spring Retainer	1	1	83	5M-122	"O" Ring (1)	1	1
37	72N-242	Valve Spring	1	1	84	71-70	Forward Clutch Cylinder	1	1
38	71-243	Pressure Reg. Valve	1	1		72-70	Forward Clutch Cylinder		1
39	10-05-239-001	Selector Valve	1	1	85	71-15B	Thrust Washer	1	1
40	4804H	"O" Ring (1)	1	1	86	B107A	Annular Bearing	1	1
41	N.S.S.*	Plastic Shipping Plug	1	1		B108A	Annular Bearing		1
42	A4740G	Breather	1	1	87	4559A	Snap Ring (2)		1
43	0000444866	3/8-16 Dryseal Plug	1	1		4734	Snap Ring (2)	1	
44	0000444687	1/8-27 Dryseal Plug	1	1	88	R6A-7-1/2	Snap Ring (2)	1	
45	10-13-559-001	Dipstick Assembly	1	1		4766B	Snap Ring (2)		1
45A	10-04-034-002	Dipstick Tube	1	1	89	4822	Ring Gear Snap Ring (2)	1	1
46	71-42	Poppet Spring (2)	1	1	90	72-A66B	Reverse Clutch Plate	2	3
47	0000453632	5/16 Steel Ball	1	1	91	72-176	Reverse Clutch Steel Plate	1	1
48	71-79B	Shift Lever	1	1	92	71-71	Reverse Clutch Pressure Plate	1	1
49	0000115729	5/16-24 Hex Nut	1	1	93	71-35	Reverse Clutch Piston	1	1
50	0000108579	5/16 Lockwasher	1	1	94	4805A	Sealing Ring (1)	1	1
51	0000103340	Washer	1	1	95	4840D	Needle Bearing	1	1
52	4885B	Bushing	1	1	96	4804G	Sealing Ring (1)	1	1
53	5L-222	Spring	1	1	97	71-144B	Gasket (1) <i>123C6</i>	1	1
54	35-143	Flat Washer	1	1	98	0000444860	1/4 Pipe Plug	1	1
55	72C-98	Pump Inlet Shield	1	1	99	71C-8	Forward & Reverse Adapter	1	1
56	10-13-565-003	Case & Magnet Assembly	1		NI	71C-A8	For. & Rev. Adapter & Needle Brg. Assy.	1	1
	10-14-565-002	Case & Magnet Assembly		1	100	4911	3/8-16 x 1-1/4 Cap Screw	4	4
57	R6-177	Dowel Pin	3		101	N.S.S.*	Pump Drive Gear	1	1
	4622E	Dowel Pin		3	102	N.S.S.*	Pump Driven Gear	1	1
57A	4806J	Sealing Ring (1)	3	3	103	3-61	Pump Gasket (1) <i>123B4</i>	1	1
58	10-00-132-003	Needle Bearing	1	1	104	N.S.S.*	Pump Housing	1	1
59	10-13-659-003	Planet Carrier Assembly	1		105	10-00-044-014	Oil Seal (1)	1	1
	10-14-659-003	Planet Carrier Assembly		1	106	10-00-183-021	5/16-18 x 1-3/8 Hex Head Bolt	4	4
60	4806S	Sealing Ring (1)	2	2	NI	71C-A60	Pump Assembly	1	1
61	10-00-132-005	Needle Bearing	1	1					
62	71-17	Thrust Washer	1	1					
63	0000124553	Woodruff Key		1					
	0000218211	Woodruff Key	1						
N1	10-04-665-002	Sun Gear & Clutch Assembly	1						
NI	10-05-665-002	Sun Gear & Clutch Assembly		1					
	72-A6	Ring Gear & Clutch Assembly		1					
64	10-04-665-001	Drive Gear & Plug Assembly	1						
	10-05-665-001	Drive Gear & Plug Assembly		1					
65	4873	No. 9 Woodruff Key	1	1					
66	71-40	Forward Clutch Hub	1						
	72-40	Forward Clutch Hub		1					
67	4495	Snap Ring (2)	1	1					
68	4806J	Sealing Rings (1)	2	2					
69	72-6	Ring Gear		1					
	71-6	Ring Gear	1						
70	4768	Snap Ring - Selective (2)		2					
	4768A	Snap Ring - Selective (2)		1					
	4768B	Snap Ring - Selective (2)		1					
71	5L-67	Pressure Plate	1	1					
73	71-97	Pressure Plate Spring (2)	12	12					
74	71-140	Baffle	1	1					
75	5C-A66A	Clutch Inner Plate	5	7					
76	3-176	Clutch Outer Plate	4	6					
77	5C-175A	Pressure Plate	1	1					

\*N.S.S. - NOT SERVICE SEPARATELY

(1) - THESE PARTS AVAILABLE GASKET & SEAL KIT NO. 10-13-410-001

(2) - THESE PARTS AVAILABLE SMALL PARTS KIT NO. 10-13-410-002

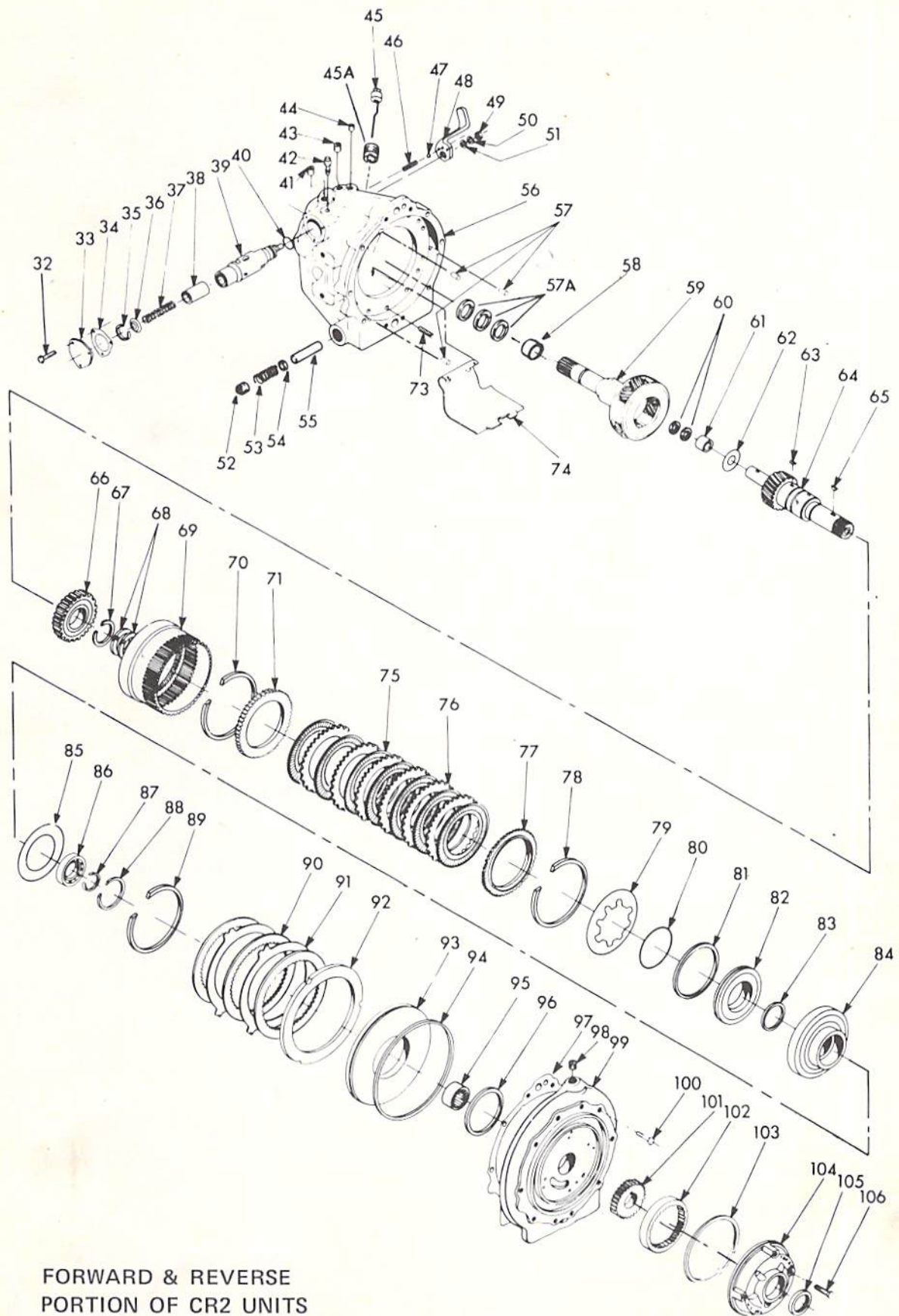

FORWARD & REVERSE  
PORTION OF CR2 UNITS

Fig. 3

PARTS LIST FOR REDUCTION OF CR2 UNITS

INDEX NO.	W.G. PART NO.	DESCRIPTION	NO. REQ.	INDEX NO.	W.G. PART NO.	DESCRIPTION	NO. REQ.
1	4775Q	Coupling Nut	1	20	10-00-133-012	Bearing Cone used in -006 units	2
2	10-00-031-001	Coupling	1		10-00-133-014	Bearing Cone used in -008 units	2
3	10-00-044-003	Oil Seal (2)	1	21	10-00-133-011	Bearing Cup used in -006 units	2
4	10-00-133-004	Bearing Cone	1		10-00-133-013	Bearing Cup used in -008 units	2
5	10-00-133-003	Bearing Cup	1	22	10-00-183-023	7/16-14 Hex. Soc. Head Screw	6
6	4572W	Plug	1	23	10-13-045-002	Gaskets (2)	1
7	10-13-565-002	Housing & Plug Assembly	1	24	10-13-172-001	Adapter for -002 units	1
8	10-13-053-002	Selective Spacer (.205 inch thick) (3)	1		10-13-172-002	Adapter for -001 & -009 units	1
	10-13-053-005	Selective Spacer (.207 inch thick)	1		10-13-172-003	Adapter for -004 units	1
	10-13-053-006	Selective Spacer (.209 inch thick)	1		10-13-172-004	Adapter for -003 & -010 units	1
	10-13-053-007	Selective Spacer (.211 inch thick)	1		10-13-172-005	Adapter for -006 units	1
	10-13-053-008	Selective Spacer (.213 inch thick)	1		10-13-172-006	Adapter for -005 & 011 units	1
	10-13-053-009	Selective Spacer (.214 inch thick)	1		10-13-172-007	Adapter for -008 units	1
	10-13-053-010	Selective Spacer (.216 inch thick)	1		10-13-172-008	Adapter for -007 & -012 units	1
	10-13-053-011	Selective Spacer (.218 inch thick)	1	25	10-00-133-015	Bearing Cup	1
	10-13-053-012	Selective Spacer (.220 inch thick)	1	26	10-00-133-016	Bearing Cone	1
9	10-13-133-005	Bearing Cup	1	27	10-13-045-001	Gasket (2)	1
10	10-13-133-006	Bearing Cone	1	28	10-00-131-003	Needle Roller (1)	
11	0000444581	Pipe Plug	1	29	10-13-193-001	Thrust Washer - used in -002 units	1
12	0000179861	7/16-14 x 1-3/8 Hex Head Bolt	6		10-13-193-002	Thrust Washer - used in -004 units	1
13	0000103322	7/16 Lockwasher	6	30	10-13-053-003	Spacer - used in -002 units	1
14	10-13-171-001	Ring Gear & Output Shaft for -002, 4, 6, 8, 9, 10, 11 & 12 units	1		10-13-053-004	Spacer - used in -004 units	1
	10-13-171-002	Ring Gear & Output Shaft for -001, 3, 5 & 7 units	1	31	10-13-053-003	Spacer - used in -002 units	1
15	4775Q	1-20 Thin Hex Nut	1		10-13-053-004	Spacer - used in -004 units	1
16	10-13-070-001	Drive Gear for -001 units 50 teeth 2 grooves	1	32	10-13-053-003	Spacer - used in -002 units	1
	10-13-070-002	Drive Gear for -002 units 50 teeth 1 groove	1		10-13-053-004	Spacer - used in -004 units	1
	10-13-070-003	Drive Gear for -003 units 39 teeth 2 grooves	1	33	10-13-084-001	Idler Gear - used in -002 units	1
	10-13-070-004	Drive Gear for -004 units 39 teeth 1 groove	1		10-13-084-002	Idler Gear - used in -004 units	1
	10-13-070-005	Drive Gear for -005 units 32 teeth 2 grooves	1		10-13-084-003	Idler Gear - used in -006 units	1
	10-13-070-006	Drive Gear for -006 units 32 teeth 1 groove	1		10-13-084-004	Idler Gear - used in -008 units	1
	10-13-070-007	Drive Gear for -007 units 27 teeth 2 grooves	1	34	10-13-193-001	Thrust Washer - used in -002 units	1
	10-13-070-008	Drive Gear for -008 units 27 teeth 1 groove	1		10-13-193-002	Thrust Washer - used in -004 units	1
	10-13-070-009	Drive Gear for -009 units 50 teeth 3 grooves	1		10-13-037-005	Selective Spacer (.066 inch thick) (3)	1
	10-13-070-010	Drive Gear for -010 units 39 teeth 3 grooves	1		10-13-037-006	Selective Spacer (.068 inch thick)	1
	10-13-070-011	Drive Gear for -011 units 32 teeth 3 grooves	1		10-13-037-007	Selective Spacer (.070 inch thick)	1
	10-13-070-012	Drive Gear for -012 units 27 teeth 3 grooves	1		10-13-037-008	Selective Spacer (.072 inch thick)	1
17	10-00-133-004	Bearing Cone	1		10-13-037-009	Selective Spacer (.074 inch thick)	1
18	10-00-133-003	Bearing Cup	1		10-13-037-010	Selective Spacer (.076 inch thick)	1
19	10-13-053-005	Selective Spacer (.207 inch thick) (3)	1		10-13-037-011	Selective Spacer (.078 inch thick)	1
	10-13-053-006	Selective Spacer (.209 inch thick)	1		10-13-037-012	Selective Spacer (.064 inch thick)	1
	10-13-053-007	Selective Spacer (.211 inch thick)	1	35	0000138887	5/8-18 x 5/8 Soc. Hd. Set Screw- used on -006 & -008 units	1
	10-13-053-008	Selective Spacer (.213 inch thick)	1	36	10-13-068-001	Idler Shaft used in -002 units	1
	10-13-053-009	Selective Spacer (.214 inch thick)	1		10-13-068-002	Idler Shaft used in -004 units	1
	10-13-053-010	Selective Spacer (.216 inch thick)	1		10-13-068-004	Idler Shaft used in -006 & -008 units	1
	10-13-053-011	Selective Spacer (.218 inch thick)	1				

(1) 34 required for -002 units and 52 required for -004 units.

(2) These parts are available in Kit No. 10-13-410-001

(3) Thickness given is approximate for ordering parts and may not be exact.

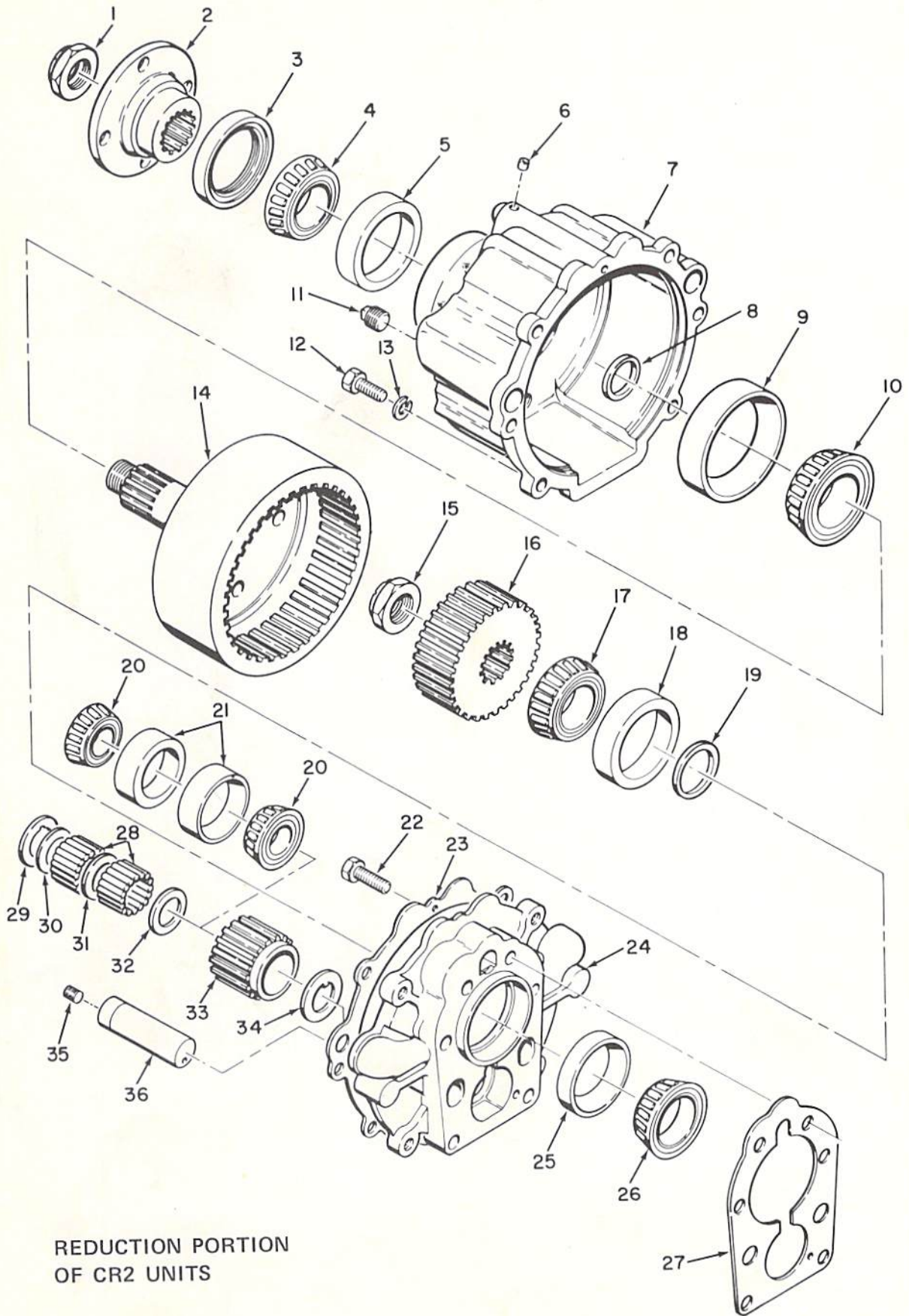

REDUCTION PORTION  
OF CR2 UNITS

Fig. 4

## SERVICE KITS

Service kits are available for convenience in handling the smaller parts. Instructions, when needed, are included in the kit. The following kits are available for CR2 units.

### A4867AB Forward Clutch Kit for All 10-14 Units

7	5C-A66A	Inner plate assembly
6	3-176	Steel Plate
1	5L-67	Pressure plate (rear)
1	5C-175A	Pressure plate (front)

### A4867AE Forward Clutch Kit for All 10-13 Units

5	5C-A66A	Inner plate assembly
4	3-176	Steel plate
1	5L-67	Pressure plate (rear)
1	5C-175A	Pressure plate (front)

### A4867AQ Forward Clutch Cylinder & Piston Assembly for All 10-13 Units

1	71-70	Forward clutch cylinder
1	71-45	Forward clutch piston
1	5L-36	Clutch ring
1	5M-122	Sealing ring
2	4806J	Sealing ring
1	5C-33	Spring bearing ring

### A4867HH Outer Pinion Kit for All 10-14 Units (1)

1	72-39	Pinion shaft
1	L3-105	Pinion, R.H.
1	4717L	Pinion shaft pin
2	72-43	Pinion thrust plate
3	L3-41	Pinion bearing spacer
48	4741A	Pinion roller

### A4867JJ Inner Pinion Kit for All 10-14 Units (1)

1	L5-39	Pinion shaft
1	R4-40	Pinion shaft pin
2	72-43	Pinion thrust plate
1	L3-5	Pinion, L.H.
3	L3-41	Pinion bearing spacer
48	4741A	Pinion roller

### A4867KK Oil Collector Ring for All 10-14 Units (1)

1	72-135	Oil collector ring
1		Instruction sheet No. 3
1		Instruction sheet No. 4

### A4867EE Oil Collector Ring for All 10-13 Units (1)

1	71-135A	Oil collector ring
1		Instruction sheet No. 1
1		Instruction sheet No. 2

### A4867FF Outer Pinion Kit for All 10-13 Units (1)

1	71-105	Pinion, R.H.
1	71-39A	Pinion shaft, outer
2	R10-41	Pinion bearing spacer
2	71-43A	Pinion thrust washer
1	R10B-40	Pinion shaft ring
12	R10-42	Pinion roller

### A4867GG Inner Pinion Kit for All 10-13 Units (1)

1	71-5	Pinion, L.H.
1	71-39	Pinion shaft, inner
2	R10-41	Pinion bearing spacer
1	R4-40	Pinion shaft pin
2	71-43A	Pinion thrust washer
19	R10-42	Pinion roller

### A4867HN Drive Gear Alarm Kit

Parts and instructions for installing a temperature warning light.

### 71-1A4A Neutral Safety Switch Kit

All parts required to install neutral start switch.

(1) These repair kits make possible replacement of individual pinions and related parts of the planetary gear sets and eliminate the necessity of replacing complete planetary assembly. Only persons who are well qualified should attempt to service planetary gear sets.

## TRANSMISSION DISASSEMBLY

- 1) Loosen coupling nut.
  - 2) Remove bolts which retain reduction housing to forward and reverse transmission.
  - 3) Pull reduction housing and attached parts from forward and reverse transmission. Remove nut, coupling, ring gear, output shaft and bearing cones from reduction housing. Press rear bearing cup from reduction housing and pull front cup from housing only if these parts need to be replaced.
  - 4) Remove nut and reduction drive gear (16).
  - 5) Remove bearing cone (17) and spacer from output shaft.
  - 6) Remove six capscrews (22) and reduction adapter.
  - 7) Press idler gear shaft (36) if used, from reduction adapter. Remove idler gear and related parts from adapter.
  - 8) Remove four capscrews from pump. Note direction in which the arrow nearer top face of pump is pointed. The pump can only pump oil when the arrow at top face of pump points in direction pump is rotated by the engine.
- NOTE:** *Pump should not be changed from original setting.*
- 9) A plastic or rubber mallet may be used to loosen pump as it is removed from transmission.
  - 10) Remove pump drive key (65) from input shaft.
  - 11) Remove the four adapter to case capscrews (100) and pull adapter from transmission. Catch loose reverse clutch parts as adapter is removed.
  - 12) Remove reverse clutch pressure plate (92), friction and steel plates (90 & 91), dowels and springs from unit.
  - 13) Pull forward clutch and ring gear assembly from transmission.
  - 14) Pull pinion cage and output shaft assembly (59) from transmission.
  - 15) Oil baffle may be removed by pressing down to snap baffle from the two spherical bosses at rear of case.
  - 16) Needle bearing should only be removed when replacing these parts.
  - 17) Disassemble ring gear and forward clutch as follows:
    - a) Remove the two snap rings from in front of annular bearings (86).
    - b) Tap front end of input shaft gently on wooden surface to cause ring gear and attached parts to slide from sun gear shaft (64).
    - c) Remove ring gear snap ring (89). Press clutch cylinder and piston from ring gear.
    - d) Remove remaining components from ring gear.

## ASSEMBLE TRANSMISSION

### ASSEMBLE FORWARD AND REVERSE TRANSMISSION

**NOTE:** *The number in parenthesis following the name of part is for reference to the part in the exploded view. Refer to figure 3 for this portion of assembly procedure.*

- 1) Press a needle bearing (58) into bearing bore at rear of case.
- 2) Press a needle bearing (61) (.30 below front face) into bore of carrier assembly.
- 3) Position front center portion of baffle (74) above and outer tabs below boss at front of case then lift curved portion at rear to snap the two large holes in baffle over the spherical bosses at rear of case.
- 4) Assemble a sealing ring (57A) into each of the three shaft (59) grooves behind carrier. Lubricate sealing ring and locate ring ends up to insure that ends will be pulled down into groove by weight of ring.
- 5) Center shaft and sealing rings in bore of case to insure against breaking sealing rings as pinion cage and output shaft are assembled into forward and reverse transmission case.
- 6) An assembly fixture or suitable blocks positioned under rear face of case should be used to hold parts assembled in steps 1 through 5 in an upright position while forward and reverse transmission assembly is completed.

## ASSEMBLE FORWARD CLUTCH AND RING GEAR

7) Place ring gear (69) on a bench with the external teeth located up. Be sure that all dirt has been cleaned from shoulder and splines of ring gear.

8) Install pressure plate (71) with ground face located up in ring gear. Pressure plate should rest squarely on shoulder at bottom of internal splines.

9) Assemble a friction plate (75) then alternating with steel (76) and friction plates, assemble either seven friction and six steel or five friction and four steel plates depending upon the model being assembled.

10) Assemble the flat side of pressure plate (77) against the top friction plate in ring gear.

11) Assemble the clutch spring snap ring (78) against ends of internal splines. This snap ring does not assemble into a groove.

**NOTE:** The clutch spring snap ring should be from .090" to .093" (2.3-2.4 mm.) thick and have a free diameter approximately 5-19/32" (14.21 cm.).

12) Assemble clutch spring (79) concave side down into ring gear. Center spring over snap ring.

13) Assemble sealing ring (81) into clutch piston (82) groove and sealing ring (83) into clutch cylinder (84) hub groove. Lubricate and assemble piston into cylinder bore. Assemble clutch spring bearing ring (80) into groove on face of piston.

14) Center the ring gear and parts assembled into it under an arbor press and press clutch piston and cylinder assembly into ring gear. Assemble the snap ring (89) into groove above clutch cylinder.

**NOTE:** The ring gear snap ring is from .074 to .078" (1.9 to 2.0 mm.) thick and has a free diameter of approximately 5-7/8" (14.9 cm.).

15) Clutch assemblies having seven friction plates use a selective snap ring (70) which must be selected and installed between the pressure plate and ring gear web. This snap ring is not used in assemblies having only five friction plates. Position clutch and ring gear on a bench with external teeth of ring gear resting on bench. Press down lightly on clutch pack while a feeler gage is used to determine the clearance between pressure plate and ring gear web, fig. 5. Select a snap ring to reduce this dimension (clutch pack clearance) to .049 to .065" (1.0 to 1.7 mm.). Two of the thinnest rings may be required.

**NOTE:** Selective snap rings have a free diameter of approximately 5-11/16" (14.55 cm.). A color code has been used to help identify each ring as to thickness as charted below:

COLOR	INCH	MM
Green	.050-.054	1.3-1.4
Orange	.074-.078	1.7-1.9
White	.096-.100	2.4-2.5

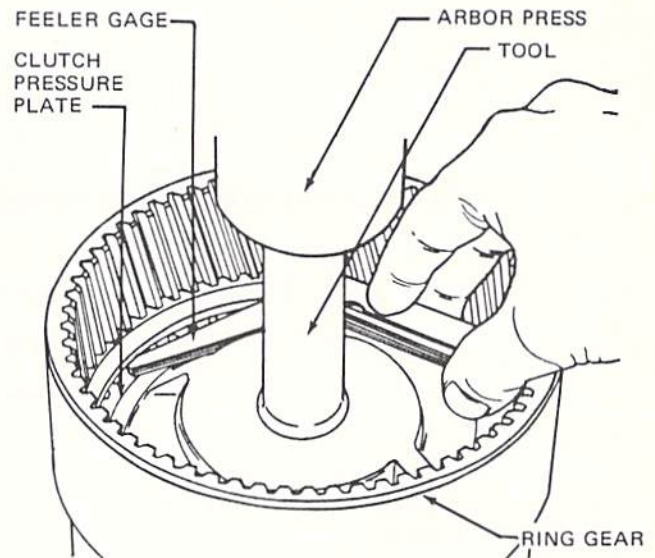

Fig. 5 MEASURING GAP FOR SELECTIVE SNAP RING

## ASSEMBLE HUB AND SEALING RING ON DRIVE GEAR

16) Assemble the Woodruff key (63) into keyway provided in drive gear (64).

17) Assemble drive gear through clutch hub (66) aligning keyway and key as parts are pressed together under an arbor press.

18) Assemble a snap ring (67) in drive gear groove in front of hub.

19) Assemble two sealing rings (68) in grooves of drive gear. Rings should be free in the grooves.

## ASSEMBLE DRIVE GEAR TO RING GEAR AND CLUTCH ASSEMBLY

20) Align clutch hub teeth with clutch plate teeth as drive gear and hub are assembled into clutch and ring gear assembly; then position these parts under an arbor press with input shaft splines up and rear face of ring gear and sun gear resting on a flat surface and shaft extended down through a hole in the support plate.

21) Press the annular bearing (86) over shaft and into clutch cylinder hub bore.

22) Install a snap ring (87) in drive gear groove in front of bearing.

23) Install a snap ring (88) in clutch cylinder hub in front of bearing.



24) Assemble a thrust washer (62) against rear face of sun gear. Use petrolatum to hold washer in position during assembly.

25) Assemble the two sealing rings (60) in grooves of drive gear shaft. Use petrolatum to hold rings in position. Do not use rings which have been cut or mutilated in any manner.

26) Rotate clutch and drive gear assembly to engage teeth as the assembly is lowered into position in transmission. Use care to prevent sealing ring damage.

27) Assemble the thrust washer (85) on face of clutch cylinder.

28) Assemble twelve pressure plate springs (73) in the holes provided in reverse clutch cavity.

29) Coat three dowel pins (57) with petrolatum and assemble in grooves provided in outer diameter of the reverse clutch cavity.

30) Assemble a reverse clutch friction plate (90) over exposed splines of ring gear.

31) Assemble a steel reverse clutch plate (91) locating the odd shaped lug over the dowel which is nearest to one of the springs. Repeat steps 29 and 30 until either two friction and one steel or three friction and two steel plates have been assembled depending upon the model being assembled.

32) Locate the twelve holes down and align the cast "V" slot of the reverse clutch pressure plate (92) with the large oil hole at the top of front face of transmission case. Springs must engage holes in pressure plate which will be level when properly assembled.

#### ASSEMBLE REVERSE CLUTCH PISTON INTO ADAPTER

33) Press the needle bearing (95) into adapter (99).

34) Assemble a clutch sealing ring (96) in adapter groove.

35) Assemble a clutch seal ring (94) in reverse clutch piston (93) groove.

36) Lubricate sealing rings and assemble piston into adapter. A smooth screwdriver may be used to help start sealing ring into cylinder bore.

37) Assemble gasket to adapter face and lower gasket and adapter straight down over input shaft and rest on front face of case. Twisting the adapter will unseat pressure plate from springs and should be avoided.

38) Assemble the four capscrews (100) and tighten evenly to the recommended torque. Should the adapter bottom against dowels, it would be necessary to loosen the capscrews and shift adapter into alignment with dowels.

39) Assemble the Woodruff key (65) into keyway in input shaft.

40) Assemble pump drive gear (101) over input shaft and drive key.

41) Assemble pump gasket (103) into pump bore on front face of adapter.

42) Coat pump seal (105) outside diameter with a suitable gasket sealer and press in until flush with front face of pump housing (104).

43) Assemble driven gear (102) into pump housing.

44) Assemble pump housing and driven gear to adapter. The arrow located nearer top of front face of pump should point in the direction indicated in the chart on page (5) for the model being assembled. The pump on CR2 units should not be indexed for opposite rotation. Models are available for both engine rotations.

45) Assemble four capscrews (106) and tighten evenly to the recommended torque.

#### ASSEMBLE REDUCTION PORTION OF TRANSMISSION

1) Press the front bearing cone (26) over forward and reverse transmission output shaft.

2) Assemble a gasket (27) to rear face of case.

3) Press bearing cups (18 & 25) into each bore of reduction unit adapter (24).

4) Assemble adapter to rear face of case. Torque the six 7/16-14 hex socket head capscrews to the recommended torque.

5) Assemble a bearing spacer (19), bearing cone (17), gear (16) and nut onto output shaft. The proper spacer must be determined by assembling these parts, torquing nut to the recommended 240 pounds feet (8.5 meter kgs.). Then, checking end play of shaft. Compressed air (approximately 90 PSI) may be fed into the line pressure tap and unit shifted into reverse to help hold output shaft while tightening output shaft nut. The output shaft should have from .0000 to .0018" (.0 to .5 mm.) end play. With the correct spacer installed, no more than 45 pounds inches (8037 gms. cm.) should be required to rotate the output shaft.

#### 6A) Assemble Idler Gear With Tapered Bearings (1.58 & 2.03:1 Units)

*Refer to figure 4 for this portion of assembly procedure.*

1) Press a bearing cup (21) into each side of idler gear. Assemble a bearing cone (20) in each bearing cup. Place gear and bearing components in approximate running

position. Use a feeler gage to determine clearance between end of bearing cones and adapter. Select a spacer which is from .001 to .002" (.02 to .05 mm.) thicker than the measured clearance to give a preload to tapered bearings.

2) Place suitable blocks against rear gasket face of adapter and lay a bar with a 5/16. (7.9 mm.) drilled hole through it to bridge over the adapter. Locate blocks and bar so that a 1/4-20 bolt may be inserted through the 5/16" hole and screwed into the 1/4-20 hole in adapter near idler shaft location. Tightening the bolt against the bar will lift the adapter boss to give clearance needed to assemble spacer and gear with bearings in a position not quite in mesh with reduction drive gear (16).

3) Loosen the 1/4-20 capscrew to permit adapter to close down to preload tapered bearings. Try turning the gear which should not spin but should not have a heavy drag. Correct bearing drag if necessary by changing the selective spacer.

4) Align gear and bearing components to permit assembling idler shaft (36). Shaft should be a drive fit for the last 1/4" (.64 cm.) of movement into adapter.

#### **6B) Assemble Idler Gear With Bearing Rollers (2.47 & 2.93:1 Unit)**

*Refer to figure 4 for this portion of assembly procedure.*

1) Assemble two rows of 17 or 26 rollers (28) with a pinion bearing spacer between rows and at each end of rollers. Petrolatum should be used to hold rollers and spacers in position.

2) Assemble the gear with rollers and spacers into position with a tabbed thrust washer at each end into position in adapter. Thrust washer tabs should be located in adapter recess.

3) Assemble idler shaft (36) through adapter boss and gear being carefull not to damage or lose rollers. Locate the drill point recess on end of shaft a 3 o'clock position when viewed behind unit. Shaft must be driven the last 1/4" (.64 cm.) into adapter press fit.

#### **ASSEMBLE REDUCTION HOUSING, BEARING & OUTPUT SHAFT**

*Refer to figure 4 for this portion of assembly procedure.*

1) Press two bearing cups to bottom of bores in reduction housing.

2) Press the larger bearing cone (10) over output shaft and against rear face of ring gear. Place a selective spacer over output shaft and locate against shoulder.

3) Assemble shaft and bearing into reduction housing. Assemble rear bearing, coupling and nut to output shaft. The oil seal should not be installed at this time. Tighten coupling nut to 240 pounds feet (8.5 meter kgs.). The correct selective spacer will cause bearings to be preloaded from .0002 to .002" (.0 to .1 mm.) and a torque wrench used to rotate output shaft should read between 1.5 to 39.0 pounds inches (268 to 6965 gm/cms.). Replace spacer with a thinner one if torque is less or with a thicker one if torque is greater than specified.

4) Remove nut and coupling after correct spacer has been selected and press an oil seal flush with rear face of reduction housing.

5) Replace coupling and nut. Apply Permatex or similar gasket cement to rear face of coupling under nut to prevent leakage through splines of shaft coupling.

6) Assemble a gasket (23) and reduction housing with attached parts to rear face of forward and reverse transmission.

7) Assemble six 7/16-14 x 1-3/8 hex head bolts to retain reduction housing to forward and reverse transmission.

## TROUBLE SHOOTING CHART

COMPLAINTS & SYMPTOMS	REMEDY	
	Transmission in Boat	Transmission Removed
<b>INTERNAL &amp; EXTERNAL LEAKS</b>		
1. Oil leaks at pump		1 2 3 8
2. Oil on exterior of trans.	1 4 6 7	2 5 8
3. Oil leaks at rear seal	3*	
4. Water in transmission oil or oil in cooling water	9	
5. Oil leak from breather	9 15 19 43	
<b>TRANSMISSION MALFUNCTIONS IN ALL RANGES</b>		
1. No oil pressure	10	11 12
2. Low oil pressure	13 14 15 16 18	17
3. High oil temperature	9 15 19 20 21 22 30	17 42
4. Failure of reduction gear		23
<b>TRANSMISSION MALFUNCTIONS IN FORWARD RANGE</b>		
1. Low oil pressure	13 14 15 16 18	17
2. Forward clutch engages improperly	37	12 20 24 25 26 27 28
3. Forward clutch drags	37	26 27 28
4. Reduction unit failure		23
<b>TRANSMISSION MALFUNCTIONS IN REVERSE RANGE</b>		
1. Low oil pressure	13 14 15 16 18	17
2. Reverse clutch engages improperly	37	24 26 28 29
3. Reverse clutch drags	37	26 28 29
4. Reverse gear set failure		42
5. Reverse gear set failure		23
<b>TRANSMISSION MALFUNCTIONS IN NEUTRAL</b>		
1. Output shaft drags excessively in forward position	37	26 27 28
2. Output shaft drags excessively in reverse rotation	37	26 28 29 42
<b>MISCELLANEOUS TRANSMISSION PROBLEMS</b>		
1. Regulator valve buzz	15 16	
2. Gear noise - forward	31	32
3. Gear noise - reverse	31	32 42
4. Pump noise	15	17 32
5. Damper noise or failure		33 34 35 36
6. Shifts hard	7 16 37 39 38	
7. High oil pressure	16 30 40 41	

\*If installation allows access, otherwise remove transmission.

### KEY TO TROUBLE SHOOTING CHART

- Item 1 Loose bolts -- tighten
- Item 2 Damaged gasket -- replace
- Item 3 Damaged oil seal -- replace
- Item 4 Oil line fitting loosened -- tighten
- Item 5 Case leaks, porosity -- replace
- Item 6 Oil filter plug leaks -- tighten or replace
- Item 7 Damaged control valve "O" ring -- replace
- Item 8 Foreign material on mating surfaces -- clean
- Item 9 Damaged oil cooler, water and oil mixing -- replace
- Item 10 No oil -- find leak and fill
- Item 11 Pump improperly located for engine rotation -- locate correctly
- Item 12 Sheared drive key -- replace
- Item 13 Faulty oil gage, replace, bleed air from gage line
- Item 14 Dirty oil screen -- clean or replace
- Item 15 Low oil level -- add oil to proper level
- Item 16 Regulator valve stuck -- polish with crocus cloth to remove burrs and clean
- Item 17 Worn oil pump -- replace
- Item 18 Regulator valve spring weight low -- replace
- Item 19 High oil level -- drain oil to proper level
- Item 20 Low water level in cooling system -- fill
- Item 21 Dirty oil cooler -- clean or replace
- Item 22 Cooler too small -- replace with larger cooler
- Item 23 Inspect reduction unit -- repair
- Item 24 Worn or damaged clutch piston oil seals -- replace
- Item 25 Worn or damaged clutch sealing rings -- replace
- Item 26 Clutch improperly assembled -- rebuild
- Item 27 Damaged or broken Bellville springs -- replace
- Item 28 Worn or damaged clutch plate(s) -- replace
- Item 29 Damaged or broken clutch springs -- replace
- Item 30 Cooler lines damaged or too small -- replace
- Item 31 Inadequate torque on output shaft nut -- tighten
- Item 32 Nicks on gears -- remove with stone
- Item 33 Excessive runout between engine housing and crankshaft -- align
- Item 34 Wrong damper assembly -- replace
- Item 35 Damaged damper assembly -- replace
- Item 36 Body fit bolts not used in mounting holes -- replace
- Item 37 Control linkage improperly adjusted -- adjust
- Item 38 Control lever and poppet ball corroded -- clean and lubricate
- Item 39 Control linkage interference -- check and adjust
- Item 40 Wrong oil used in transmission -- change
- Item 41 Cold oil
- Item 42 Planetary gear failure -- replace or repair
- Item 43 Damaged breather -- replace

## BOLT TORQUE CHART FOR CR2 UNITS

PART NUMBER	PART DESCRIPTION	POUNDS FEET	METER KILOGRAMS
0000444687	1/8-27 Dryseal Plug	7-12	.97-1.66
0000444866	3/8-18 Dryseal Plug	16-27	2.35-3.73
4885B	Bushing	25-35	3.46-4.84
4911	3/8-16 x 1-1/4 capscrew	27-37	3.73-5.12
0000444858	1/4 Pipe Plug	12-20	1.66-2.77
10-00-183-021	5/16-18 x 1-3/8 Hex Head Bolt	17-22	2.35-3.05
0000115729	5/16-24 Hex Nut	8-11	.41-1.52
0000179793	1/4-20 x 5/8 Hex Head Bolt	8-11	.41-1.52
10-00-183-023	7/16-14 Hex Socket Head Capscrew	73-83	10.10-11.48
4775Q	1-20 Thin Hex Nut	220-260	29.43-35.96
0000138887	5/8-18 x 5/8 Socket Head Set Screw	10-20	1.38-2.77
0000444581	3/8-18 Square Head Pipe Plug	17-27	2.35-3.73
0000179861	7/16-14 x 1-3/8 Hex Head Bolt	50-60	6.92-8.30

## MARINE TRANSMISSION LIMITED WARRANTY TO ENGINE MANUFACTURERS

Seller guarantees its products against defective material or workmanship for a period of 12 months or 400 hours whichever occurs first from date of delivery to the first owner-operator. Seller's obligation under this guarantee is limited to replacement or repair of any defective material when returned f.o.b. Seller's factory at Muncie, Indiana and shall be subject to Seller's inspection and verification of claim.

Purchasers of engines or boats using our products should follow the procedure designated in the warranty policy supplied by the company from whom the product was purchased.

WARNER GEAR  
Division of Borg-Warner Corporation  
Muncie, Indiana